

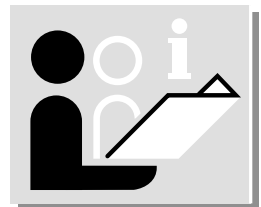

KÄRCHER

CV 30/1

CV 38/1

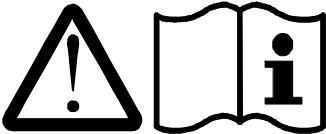
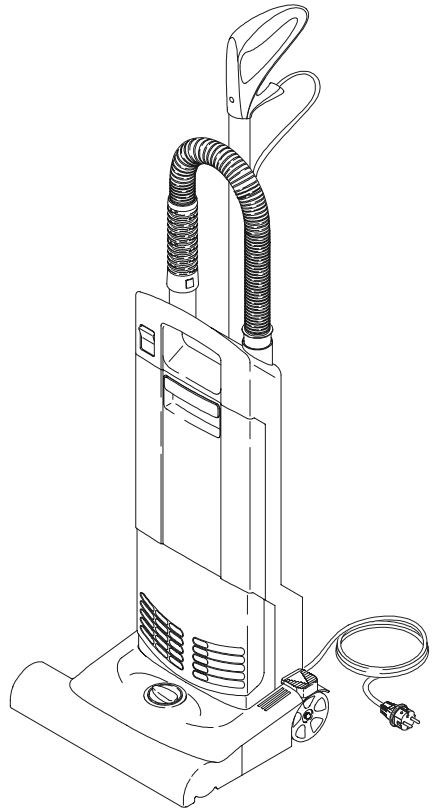
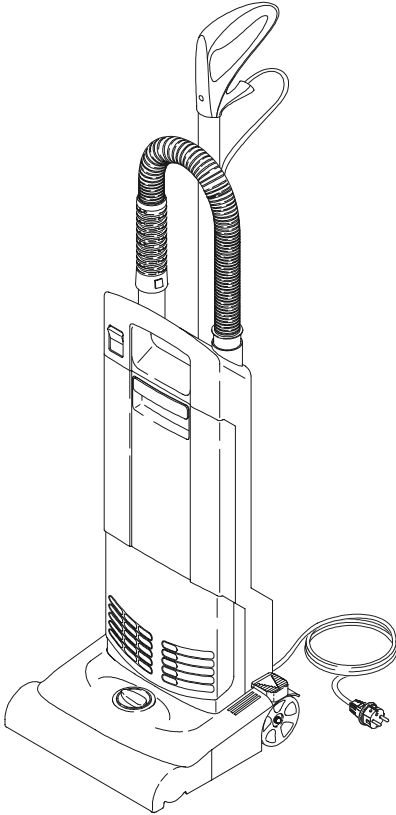

Deutsch

Inbetriebnahme	8
Betrieb	9
Wartung	14
Störungen	18 20
Technische Daten	66
Schaltplan	67
Ersatzteilliste	68

Vor erster Inbetriebnahme Betriebsanleitung und Sicherheitshinweise Nr. 5.956-249 unbedingt lesen!
Dieses Gerät ist für den gewerblichen Gebrauch geeignet, z.B. in Hotels, Schulen, Krankenhäusern, Fabriken, Läden, Büros und Vermietergeschäften.

English

Commissioning	8
Operation	9
Maintenance	14
Faults	18 22
Technical Specifications	66
Wiring diagram	67
Spare Parts List	68

Prior to initial operation it is mandatory to read the operating instructions and the notes on safety no. 5.956-249 This unit is suitable for commercial use, e.g. in hotels, schools, hospitals, factories, shops, offices and leased properties.

Français

Mise en service	8
Fonctionnement	9
Maintenance	14
Anomalies	18 24
Données techniques	66
Schéma de câblage	67
Liste des pièces de rechange	68

Avant la première mise en service, lire absolument le mode d'emploi et les consignes de sécurité n° 5.956-249 ! Cet appareil est adapté à l'usage commercial p. ex. dans les hôtels, les écoles, les hôpitaux, les usines, les magasins, les bureaux et les sociétés de location.

Italiano

Messa in funzione	8
Esercizio	9
Manutenzione	14
Disturbi	18 26
Dati tecnici	66
Schema elettrico	67
Elenco pezzi di ricambio	68

Prima della prima messa in funzione, leggere assolutamente le istruzioni per l'uso e le avvertenze di sicurezza n.5.956-249! Questo apparecchio è adatto per l'utilizzo professionale, ad es. in alberghi, scuole, ospedali, fabbriche, negozi, uffici e agenzie di locazione.

Nederlands

Inbedrijfstelling	8
Gebruik	9
Onderhoud	14
Storingen	18 28
Technische gegevens	66
Schakelschema	67
Reserveonderdelenlijst	68

Voor de eerste ingebruikneming de handleiding en veiligheidsaanwijzingen nr. 5.956-249 absoluut lezen! Dit apparaat is voor professioneel gebruik geschikt, bijv. in hotels, scholen, ziekenhuizen, fabrieken, winkels en kantoren.

Español

Puesta en servicio	8
Servicio	9
Entretimiento	14
Anomalías	18 30
Características Técnicas	66
Diagrama de conexiones	67
Lista de piezas de requesto	68

Leer imprescindiblemente las instrucciones de servicio y los avisos de seguridad n.º 5.956-249 antes de la primera puesta en servicio. Este aspirador es apropiado para usos comercial, p. ej. en hoteles, escuelas, hospitales, fábricas, tiendas, oficinas y locales afines.

Português

Colocação em funcionamento	8
Operação	9
Manutenção	14
Avárias	18 32
Dados Técnicos	66
Esquema de ligações	67
Lista de peças sobresselentes	68

Antes da primeira colocação em funcionamento deve ler impreterivelmente o manual de instruções e as indicações de segurança n.º 5.956-249! Este aparelho destina-se ao uso industrial, p.ex. em hotéis, escolas, hospitais, fábricas, lojas, escritórios e lojas à exploração.

Ελληνικά

Θέση σε λειτουργία	8
Λειτουργία	9
Συντήρηση	14
Βλάβες	18 34
Τεχνικά χαρακτηριστικά	66
Κυκλωματικό διάγραμμα	67
ανταλλακτικά	68

Πριν από την πρώτη θέση λειτουργίας διαβάστε οπωσδήποτε τις Οδηγίες λειτουργίας και τις Υποδείξεις ασφαλείας με αριθμ. 5.956-249! Η συσκευή αυτή είναι κατάλληλη για επαγγελματική χρήση, π.χ. σε ξενοδοχεία, σχολεία, νοσοκομεία, εργοστάσια, καταστήματα, γραφεία και εταιρίες ενοικιάσεων.

Dansk

Ibrugtagning	8
Drift	9
Vedligeholdelse	14
Driftsforstyrrelser	18 36
Tekniske data	66
Strømskema	67
Reservedelsliste	68

Inden første ibrugtagning skal man ubetinget læse driftsvejledningen og sikkerhedshenvisningerne nr. 5.956-249! Dette apparat egner sig til erhvervsmæssig brug, f.eks. i hoteller, skoler, sygehuse, fabrikker, forretninger, kontorer og udlejninger.

Norsk

Oppstart	8
Drift	9
Vedlikehold	14
Feil	18 38
Tekniske data	66
Koplingskjema	67
Reservedelsliste	68

Det er tvungende nødvendig å lese bruksanvisningen og sikkerhetsinstruksjonene nr. 5.956-249 før første oppstart! Denne maskinen er egnet for bruk i næring, f.eks. på hoteller, skoler, sykehus, fabrikker, butikker, kontorer og utleiebutikker.

Svenska

Idrifttagning	8
Drift	9
Underhåll	14
Störningar	18 40
Tekniska data	66
Kopplingschema	67
Reservdelista	68

Före första idrifttagningen måste instruktionsboken och säkerhetsföreskrifterna nr 5 956-249 läsas igenom! Denna maskin är lämpad för yrkesmässig användning, i t.ex. hotell, skolor, sjukhus, fabriker, butiker, kontor och för uthyrning.

Suomi

Käyttöönotto	8
Käyttö	9
Huolto	14
Häiriöt	18 42
Tekniset tiedot	66
KytKentäkaavio	67
Varaosalista	68

Ennen ensi käyttöönottoa on ehdottomasti luettava käyttöohjeet ja turvallisuusohjeet nro 5.956-249! Tämä laite soveltuu ammattimaiseen käyttöön, esim. hotellissa, koulussa, sairaalassa, tehtaassa, myymälässä, toimistossa tai vuokraamossa.

Magyar

Üzembelyezés	8
Üzem	9
Karbantartás	14
Üzemzavarok	18 44
Műszaki adatok	66
Kapcsolási rajz	67
Cserealkatrészlista	68

Az első üzembelyezés előtt az üzemeltetési utasítást és a 5.956-249 sz. biztonságtechnikai útmutatót okvetlenül el kell olvasni. Ez a készülék az iparszerű használatra alkalmas, pl. szállodákban, iskolákban, kórházakban, gyárakban, üzletekben, irodákban és kölcsönző boltokban.

Česky

Uvedení do provozu	8
Provoz	9
Údržba	14
Poruchy	18 46
Technické údaje	66
Schéma zapojení	67
Seznam náhradních dílů	68

Před prvním uvedením do provozu si v každém případě laskavě přečtete tento návod k použití a bezpečnostní pokyny č. 5.956-249. Tento přístroj je určen pro živnostenské využívání, a to např. v hotelech, školách, nemocnicích, továrnách, skladech, úřadech a pro účely pronajímání přístroje.

Slovensko

Zagon	8
Obratovanje	9
Vzdrževanje	14
Motnje	18 48
Tehnični podatki	66
Vežalni načrt	67
Seznam nadomestnih delov	68

Pred prvim zagonom obvezno preberite Navodila za upravljanje in Varnostne napotke šte. 5.956-249 ! Ta naprava je primerna za obrtno rabo, n.pr. v hotelih, šolah, bolnišnicah, tovarnah, prodajalnah, pisarnah in posojilnicah.

Polski

Uruchamianie	8
Eksplatacja	9
Konserwacja	14
Zakłócenia	18 50
Dane techniczne	66
Schemat ideowy	67
Lista części zamiennych	68

Przed pierwszym uruchomieniem należy przeczytać instrukcję eksploatacji oraz wskazówki na temat bezpieczeństwa nr 5.956-249! Urządzenie nadaje się do użytku zawodowego, np. w hotelach, szkołach, szpitalach, fabrykach, sklepach, biurach i placówkach wynajmujących.

Românește

Punere în funcțiune	8
Funcționare	9
Întreținere	14
Avarii	18 52
Date tehnice	66
Planul de conexiuni	67
Listă de piese de schimb	68

Înainte de prima punere în funcțiune, citiți obligatoriu manualul de utilizare și instrucțiunile de securitate nr. 5.956-249! Acest aparat este destinat uzului profesional, de ex. în hoteluri, școli, spitale, fabrici, magazine, birouri și spații comerciale închiriate.

Türkçe

Devreye sokma	8
İşletme	9
Bakım	14
Arızalar	18 54
Teknik özellikler	66
Tevzi planı	67
Yedek parça listesi	68

İlk kez devreye sokma işleminden önce, işletme kılavuzu ve güvenlik bilgileri no. 5.956-249 kesinlikle okunmalıdır! Bu cihaz ticari kullanım için uygundur, örn. otellerde, okullarda, hastanelerde, fabrikalarda, dükkan, mağaza ve marketlerde, bürolarda ve kiralayıcı işletmelerde.

Cihazın kullanım ömrü 10 yıldır.

Русский

Ввод в эксплуатацию	8
Эксплуатация	9
Техобслуживание	14
Неисправности	18 56
Технические характеристики	66
Электрическая схема	67
Запасные части	68

Перед первым вводом в эксплуатацию обязательно прочитайте руководство по эксплуатации и указания по безопасности № 5.956-249! Данный аппарат предназначен для профессионального использования, например, в гостиницах, школах, больницах, на предприятиях, в магазинах, офисах и для сдачи в аренду.

Slovensky

Uvedenie do prevádzky	8
Prevádzka	9
Údržba	14
Poruchy	18 58
Technické údaje	66
Schéma zapojenia	67
Zoznam náhradných dielov	68

Pred prvým uvedením do prevádzky si bezpodmienečne musíte prečítať návod na použitie a bezpečnostné pokyny č. 5.956-249! Tento spotrebič je vhodný pre profesionálne použitie napr. v hoteloch, školách, nemocniciach, fabrikách, obchodoch, kanceláriách a požičovniach.

Hrvatski

Puštanje u pogon	8
Pogon	9
Održavanje	14
Smetnje	18 60
Tehnički podaci	66
El. shema	67
Popis rezervnih dijelova	68

Prie prvog puštanja u pogon obavezno pročitati upute za upotrebu i sigurnosne napomene Br. 5.956-249! Ovaj uređaj je namjenjen samo za upotrebu u poslovnim prostorijama, npr, u hotelima, školama, bolnicama, tvornicama, trgovinama, kancelarijama i društvima za izdavanje.

Srpski

Puštanje u pogon	8
Rad	9
Održavanje	14
Smetnje	18 62
Tehnički podaci	66
Razvodni plan	67
Spisak rezervnih delova	68

Pre prvog puštanja u pogon obavezno pročitati uputstvo za upotrebu i sigurnosne napomene Br. 5.956-249! Ovaj uređaj je namenjen samo za upotrebu u poslovnim prostorijama, npr, u hotelima, školama, bolnicama, fabrikama, radnjama, kancelarijama i društvima za izdavanje.

Български

Пускане	8
Работа	9
Поддръжка	14
Повреди	18 64
Технически данни	66
Схема за включване	67
Списък на резервни части	68

Преди първоначалното пускане непременно прочетете Инструкцията за експлоатация и Указанията за безопасност № 5.956-249! Този уред е подходящ за професионално използване, напр. в хотели, училища, болници, фабрики, магазини, офиси и за фирми, даващи под наем.

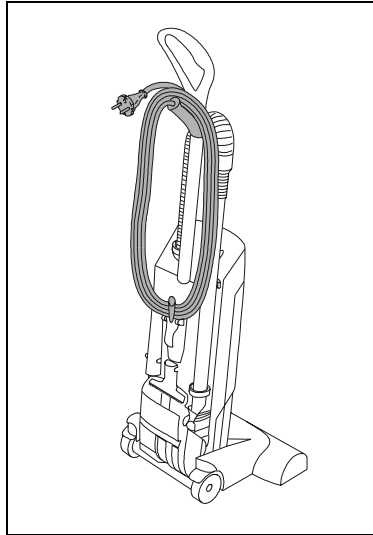
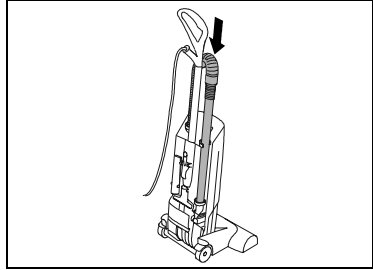
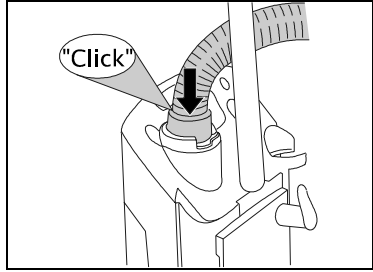
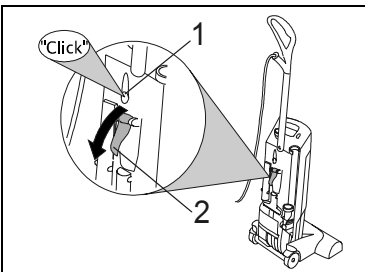
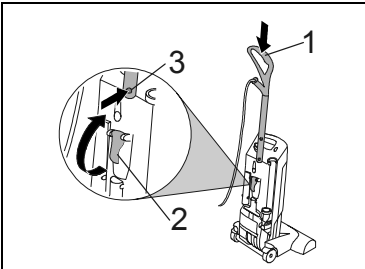
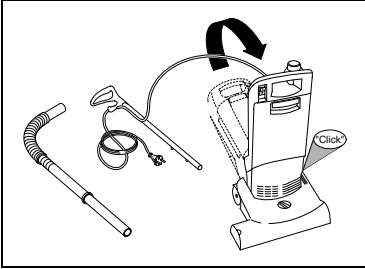
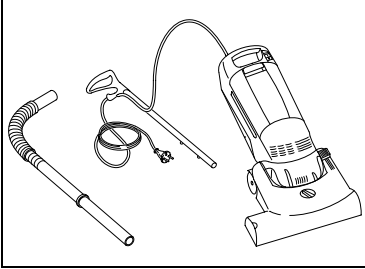
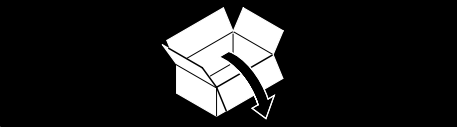

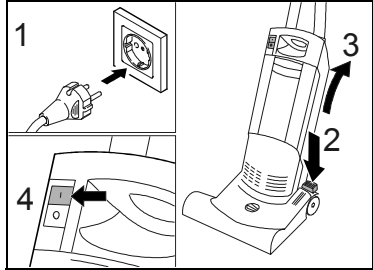
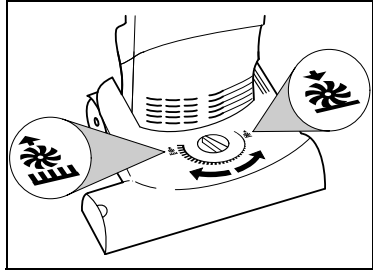
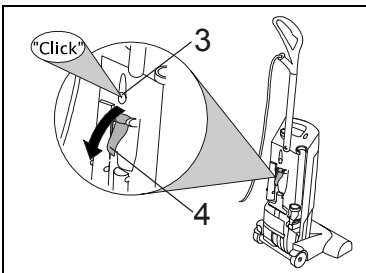
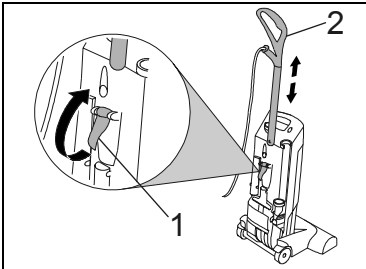
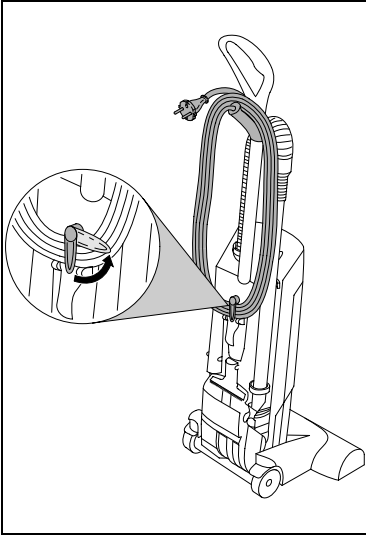

DE

**Achtung!**

Beim Saugen mit dem Saugschlauch darf der Bürstenkopf mit der rotierenden Bürstenwalze nicht auf hochflorige Teppiche gestellt werden. Der Teppich könnte bei einer längeren Verweildauer der rotierenden Bürstenwalze beschädigt oder zerstört werden.

EN

**Attention!**

When sucking with the vacuum wand, the brush head with the rotating brush roller may not be placed on a long pile carpet. Longer contact with the rotating brush roller could damage or destroy the carpet.

FR

**Attention!**

Lors de l'aspiration avec le flexible, la tête de la brosse avec rouleau rotatif ne doit pas être mise sur le tapis à poils longs. Le tapis pourrait être endommagé, voire détruit si le rouleau de brosse rotatif restait longtemps sur celui-ci.

IT

**Attenzione!**

Durante l'aspirazione con il tubo flessibile di aspirazione la testa portaspazzola con il rullospazzola rotante non deve essere poggiata su tappeti a felpa lunga. In caso di una durata prolungata del contatto il tappeto potrebbe subire danni o addirittura essere distrutto.

NL

**Let op!**

Bij het zuigen met de zuigslang mag de borstelkop met de roterende borstelwals niet op hoogpolige tapijten gezet worden. Als de roterende borstelwals langere tijd op het tapijt staat, kan dit beschadigd worden of kapot gaan.

ES

**Atención!**

Al aspirar con la manguera evite colocar la cabeza cepilladora con el cilindro en rotación sobre moquetas de fibra larga. La moqueta de fibra larga podría estropear o destruir al cabo de un rato el cilindro rotatorio cepillante.

PT

**Atenção!**

Ao aspirar com o tubo, a cabeça de escovas não pode ser colocada com o cilindro de escovas rotativo activo sobre alcatifas de pelo alto. A alcatifa pode ser danificada ou destruída se o cilindro de escovas rotativo permanecer muito tempo sobre ela.

EL

**Προσοχή!**

Κατά την αναρρόφηση με το λάστιχο αναρρόφησης η κεφαλή της βούρτσας δεν επιτρέπεται να τοποθετείται με τον περιστρεφόμενο κύλινδρο βούρτσας σε μοκέτες με σγουρό βελούδο.

Σε περίπτωση μεγάλης παραμονής του περιστρεφόμενου κυλίνδρου βούρτσας ενδέχεται να πάθει βλάβη ή να καταστραφεί η μοκέτα.

DA

**Bemærk!**

Ved sugning med sugeslangen må børstehovedet med den roterende børstevalse ikke stilles på tæpper med høj luv.

Hvis den roterende børstevalse står på tæppet i længere tid, kan dette blive beskadiget eller ødelagt.

NO

**Advarsel!**

Når man suger med sugeslangen, må børstehodet med den roterende børstevalsen ikke settes ned på tepper med høy flor.

Hvis den roterende børstevalsen blir værende lenge på teppet, kan dette bli skadet eller ødelagt.

SV

**OBS!**

Vid sugning med sugslangen får inte borsthuvudet med den roterande borstvalsen ställas ner på mattor med lång lugg.

Hålls den roterande borstvalsen stilla på ett och samma ställe under längre tid kan mattan skadas eller förstöras.

FI

**Huomio!**

Kun imuroidaan imuletkua käyttäen, harjapään pyörivää harjatelaa ei saa laittaa korkeanukkaisia mattoja vasten.

Jos pyörivää harjatelaa pidetään matolla pitempään, matto voi vahingoittua tai tuhoutua.

HU

**Figyelem!**

Ha a szívótömlővel porszívózunk, a forgó kefehengerrel rendelkező kefefejét ben szabad hosszúszálú szőnyegre helyezni.

Ha a forgó kefehenger hosszabb ideig marad a szőnyegen, az megsérülhet vagy akár tönkre is mehet.

CS

**Pozor!**

Během vysávání pomocí sací hadice se hlava kartáče s rotujícím válcem nesmí stavět na koberec s vysokým vlasem. Déle trvající působení hlavy kartáče s rotujícím válcem na koberec může vést k jeho poškození nebo zničení.

SL

**Pozor!**

Pri sesanju s sesalno cevjo ne sme biti glava ščetke z vrtečim se krtačnim valjem postavljena na visokoflorne preproge. Preproga se lahko pri daljši ležalni dobi vrtečega se krtačnega valja poškoduje ali uniči.

PL

**Uwaga!**

Podczas odkurzania węzłem nie wolno ustawiać głowicy szczotki z wirującym walcem szczotkowym na dywanach o wysokim włosiu. Przy dłuższym przytrzymaniu wirującego walca szczotkowego może nastąpić uszkodzenie lub zniszczenie dywanu.

RO

**Atenție!**

La aspirare cu furtunul, capul periei cu valț rotitor nu are voie să fie fixat pe mochete cu peri înalți.

În cazul unei perioade mai lungi de oprire a valțului rotitor cu perie, mocheta poate fi deteriorată sau distrusă.

TR

**Dikkat!**

Emme hortumu ile emme işlemi yapıldığında, dönen fırça merdaneli fırça kafası yüksek tüylü halılar üzerinde konmamalıdır.

Dönen fırça merdanesi halı üzerinde uzun bir süre kalırsa, halı zarar görür veya tahrip olur.

RU

**Внимание!**

При всасывании с помощью всасывающего шланга щетку с вращающимся валиком нельзя настраивать на ковры с высоким ворсом.

При длительном воздействии вращающегося щеточного валика не исключено повреждение или уничтожение ковра.

SK**Pozor!**

Počas vysávania sacou hadicou sa hlavica s rotujúcou valcovou kefou nesmie postaviť na koberec s vysokým vlasom. Pri dlhšom pôsobení rotujúcej valcovej kefy na koberec by mohlo dôjsť k jeho poškodeniu alebo zničeniu.

HR**Pozor!**

Pri usisavanju s usisnim crijevom glava s četkama s rotirajućom valjkastom četkom ne smije biti stavljana na tepihe sa dugačkim vlaknima. Tepih bi kod duljeg vremena zadržavanja rotirajuće valjkaste četke mogao biti oštećen ili uništen.

SR**Pažnja!**

Pri usisavanju s usisnim crevom glava sa četkama sa rotirajućom valjkastom četkom ne sme biti stavljana na tepihe sa dugačkim vlaknima. Tepih bi kod dužeg vremena zadržavanja rotirajuće valjkaste četke mogao biti oštećen ili uništen.

BG**Внимание!**

При изсмукване със смукателния маркуч главата на четката с въртящия се валик да не се поставя върху килими с висока флора.

При по-продължителна употреба на въртящия се валик на четката килима може да се повреди или разруши.

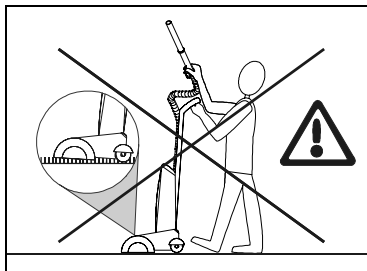
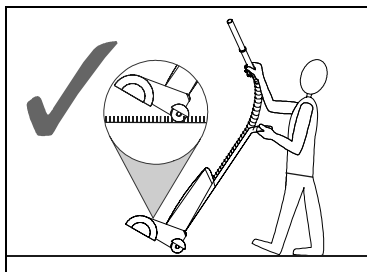
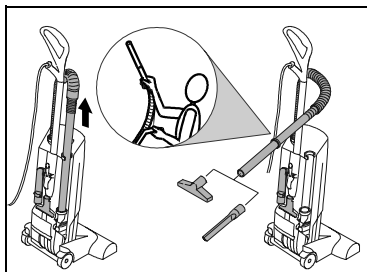

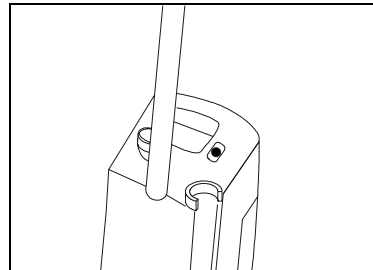
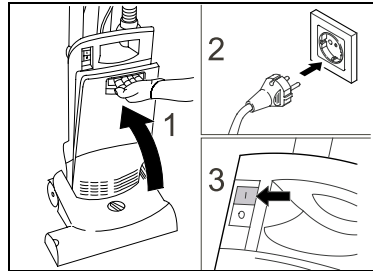
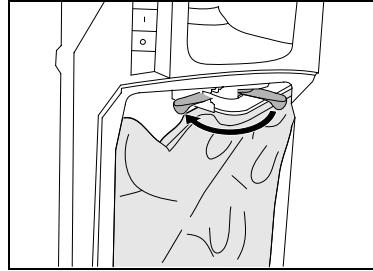
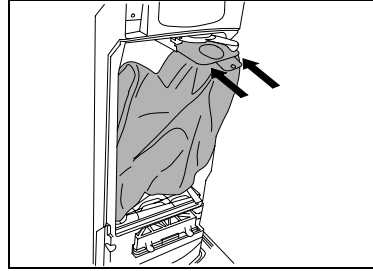
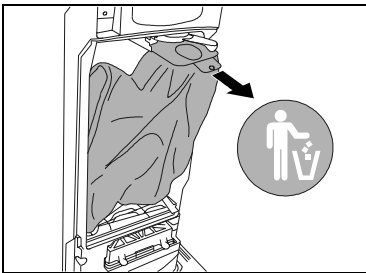
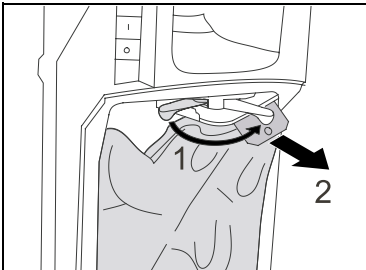
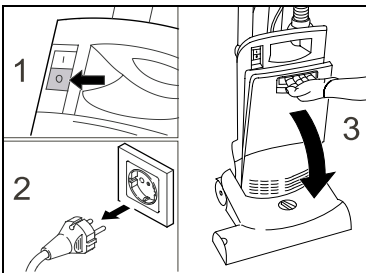
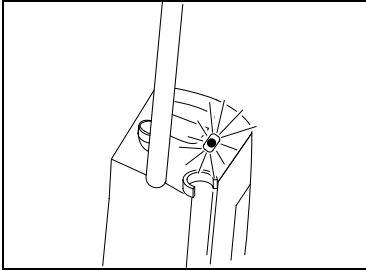
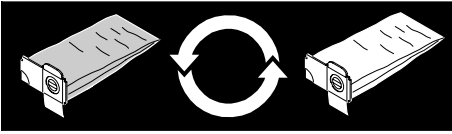

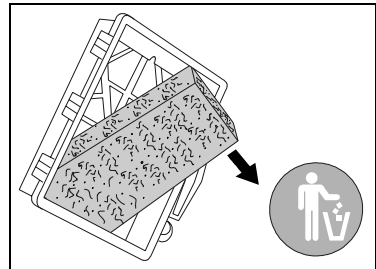
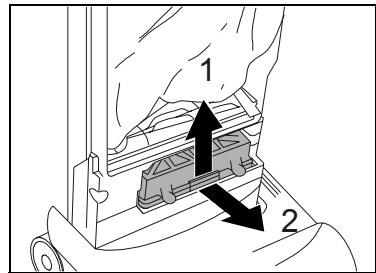
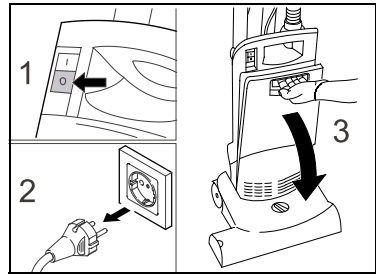
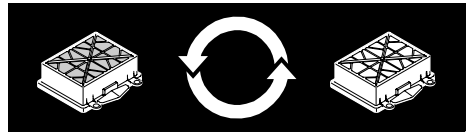
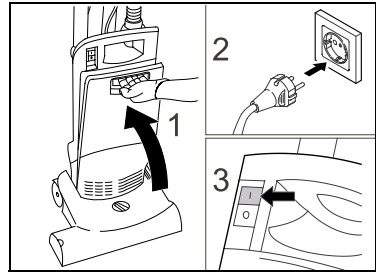
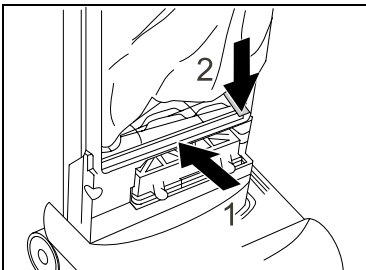
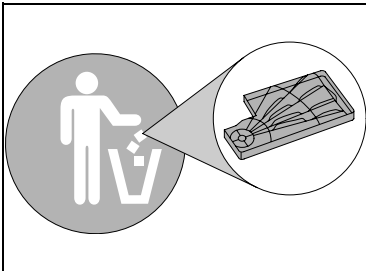
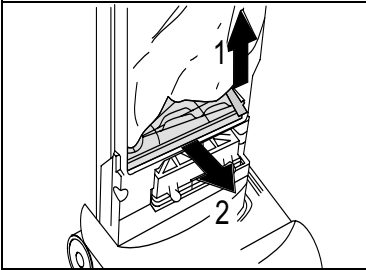
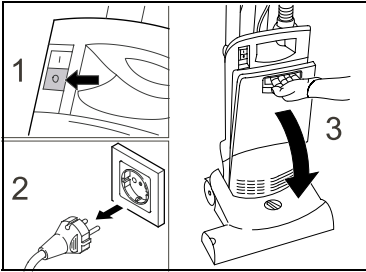
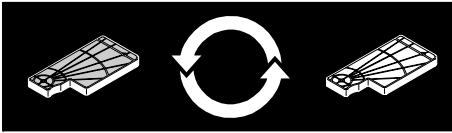

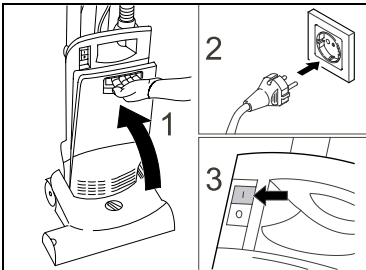
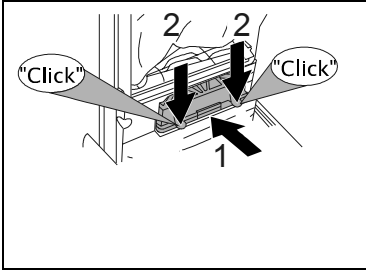
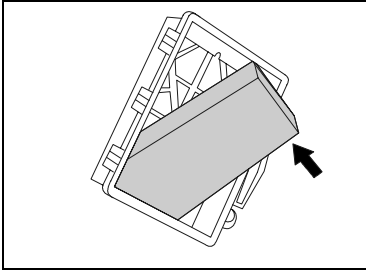

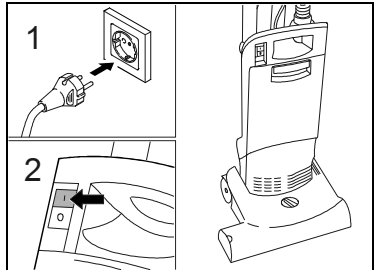
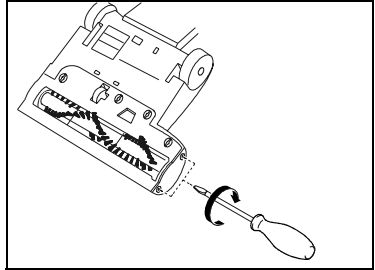
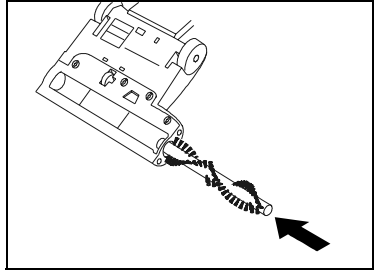
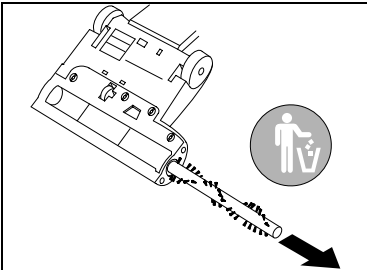
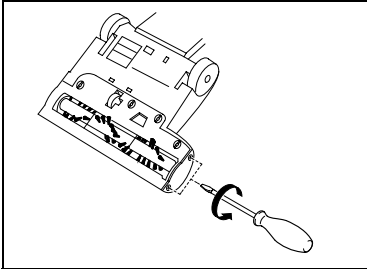
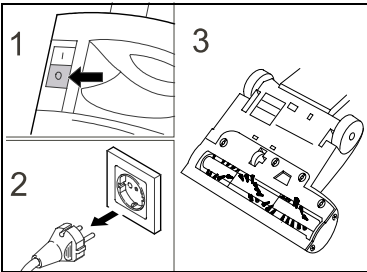
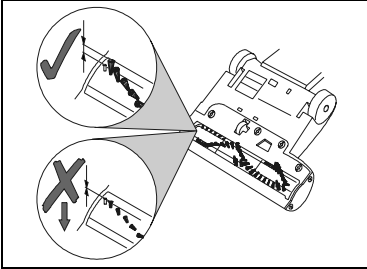
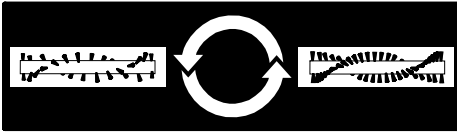

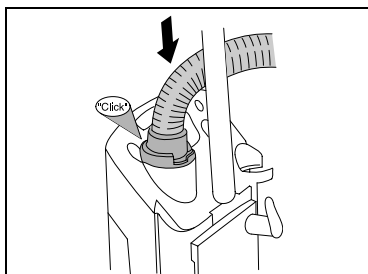
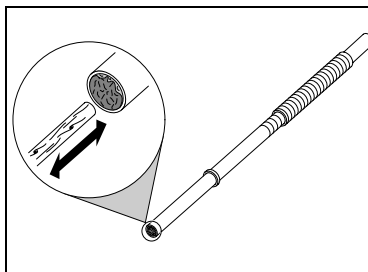
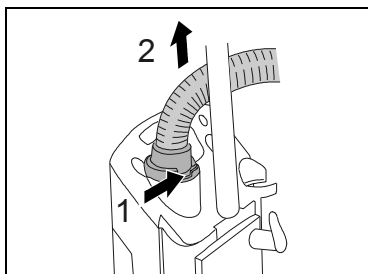
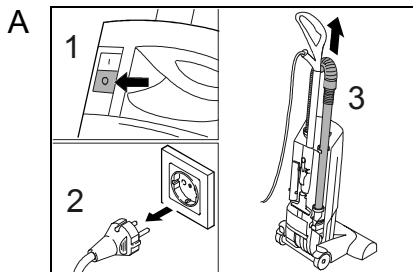
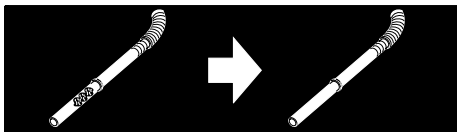
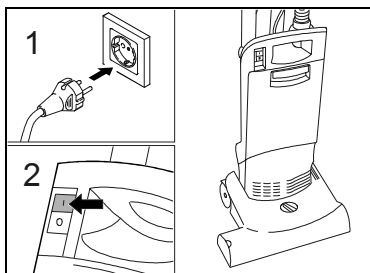
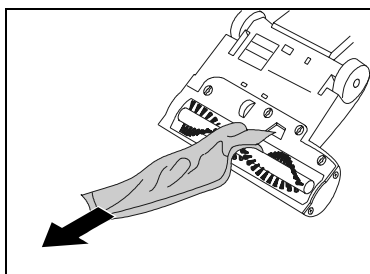
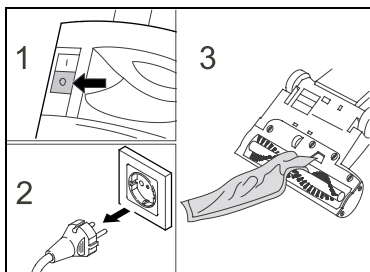
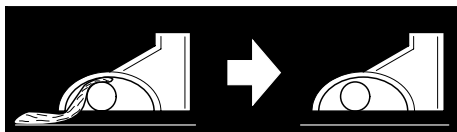

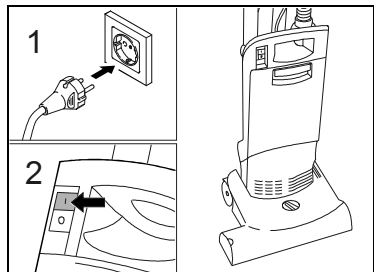
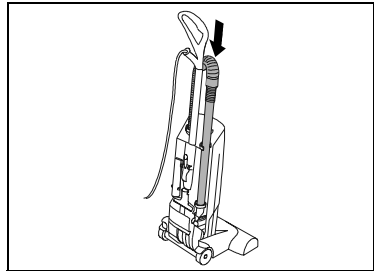
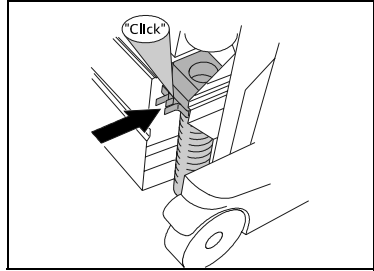
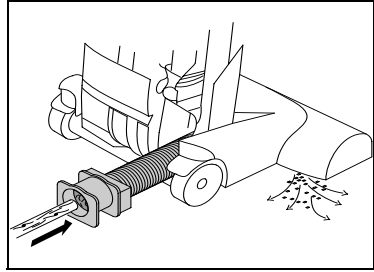
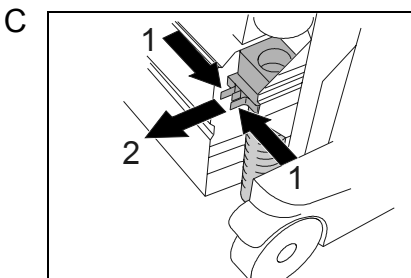
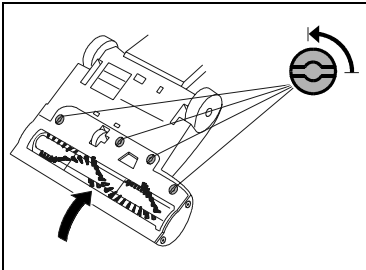
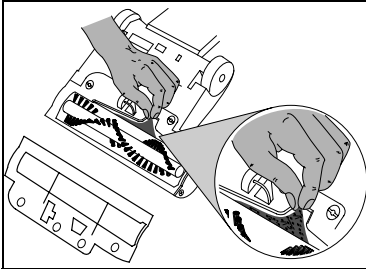
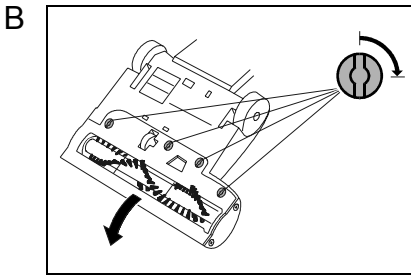

Malfunctions

Motor does not run

- Check cable, plug, fuse and socket outlet.
- Thermal switch has switched Off the engine due to overheating.
- Pull out the main plug, change the blocked filter or clear the obstruction in the suction pipe. The unit is ready for operation again after cooling down.
- Switch on unit.

Rattling noise when switched off

Note:

The brush is equipped with a slip clutch which disengages when excessively large objects or blockages are sucked in.

The clutch only engages when the unit is switched off, resulting in a loud rattling noise.

- Check brush for blockages and remove if necessary.

The noise is no longer heard when the unit is switched back on.

Suction result unsatisfactory

- Check brush for blockages.
- Remove obstructions from brush head, suction tube and suction hose.
- Changing the filter bag.
- Change blow-out filter or motor protection filter.
- Check pile height adjusting knob for correct setting.
- With heavy brush wear this must be replaced. The degree of wear is recognisable by comparing with the different coloured indicator bristles (see figure item 4). If the black bristles are

the same height as the red ones, the brush has to be replaced.

Red control lamp lit up

- Remove obstructions from brush head, suction tube and suction hose.
- Changing the filter bag.

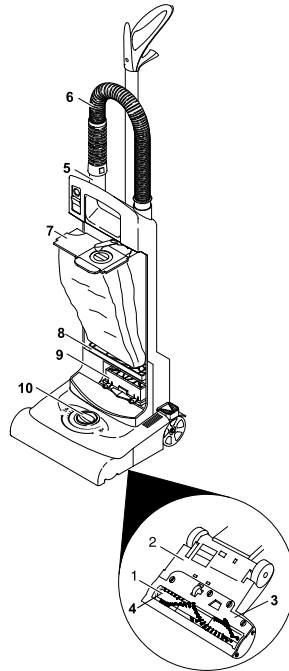

1. Brush
2. Brush head
3. Brush cover
4. Indicator bristles
5. Suction pipe
6. Suction hose
7. Filter bag
8. Engine protection filter
9. Blow-out filter
10. Adjustment knob pile height

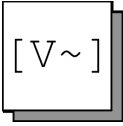

EUR: 220 - 240 V / 1 ~ 50 Hz / 60 Hz
GB : 220 - 240 V / 1 ~ 50 Hz / 60 Hz

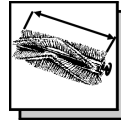

CV 30/1 : 300 mm
CV 38/1 : 380 mm



12 m H05VV-F2x1
EUR: 4.649-002
GB : 4.649-003

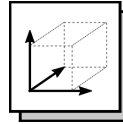

CV 30/1 : 1220 mm x 310 mm x 320 mm
CV 38/1 : 1220 mm x 390 mm x 320 mm

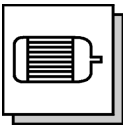

P max: 1150 W

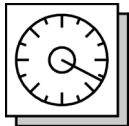

max. 20,7 kPa (207 mbar)

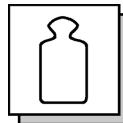

CV 30/1 : 8,6 kg
CV 38/1 : 8,8 kg

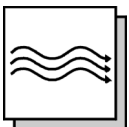

max. 48 l/s



68 dB (A)

Stromlaufplan / Circuit diagram / Schéma de circuit

CV 30/1 CV 38/1

0.088-614.0

100/120V ~	50/60Hz
220/240V ~	50/60Hz

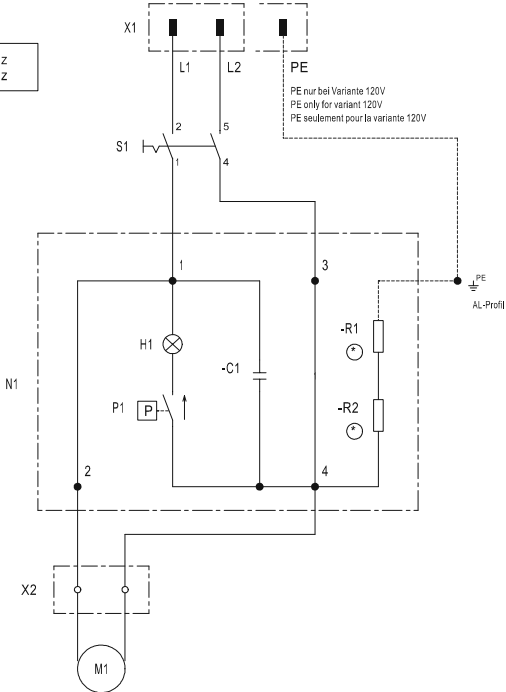

C1	Entstörkondensator Suppression capacitor Condensateur antiparasites	S1	Hauptschalter Mainswitch Interrupteur principal
H1	Kontrolllampe Pilot lamp Lampe de contrôle	X1	Netzstecker Power supply plug Prise d'alimentation d'énergie
M1	Saugturbine Vacuum motor Turbine d'aspiration	X2	Klemmen Binder Borne
N1	Schaltelektronik Electronic switch unit Unité électronique	R1/R2	Antistatikableitung, entfällt bei Var. 120 V Wire antistatic, not Var. 120 V Cable antistatique, non Var. 120 V
P1	Druckschalter Pressure switch Interrupteur à pression		

CV 30/1

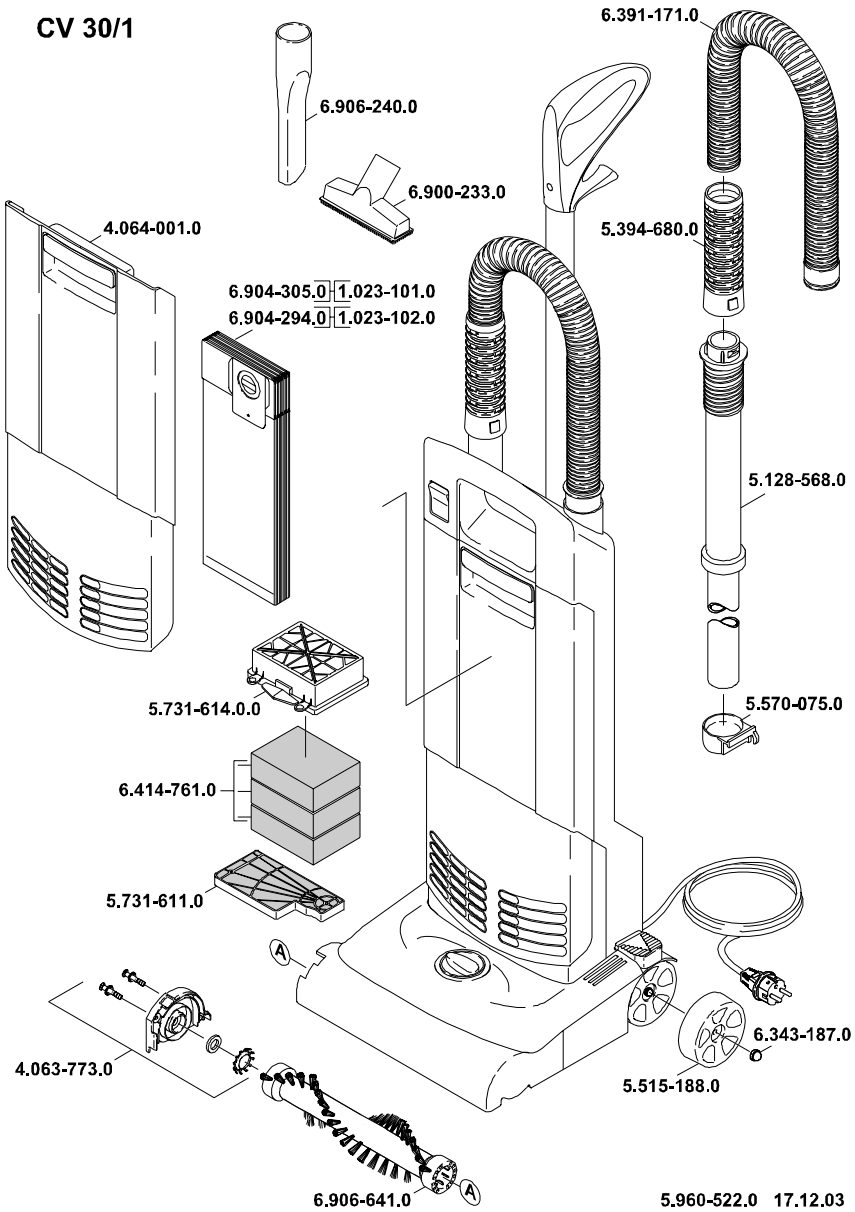

CV 38/1

